

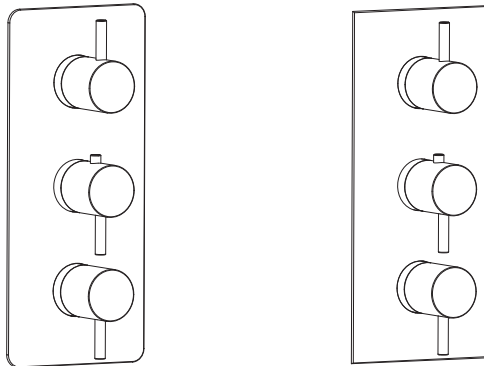

Coordinated Bathrooms Designed For You

Installation & maintenance instructions



Concealed thermostatic shower valve three hole and two/three outlets

with round or square corner backplate $\frac{3}{4}$ "

Important - please read

Please read these instructions carefully before starting installation and keep for future reference.

Remove all packaging and check the product for missing parts or damage before starting installation.

Any alterations made to this product and fittings may infringe water regulations and will invalidate the guarantee.

The installation must comply with all Local/National Water Supply Authority Regulations/Byelaws and Building and Plumbing (UK:BS6700) Regulations.

We strongly recommend that you use a qualified and registered plumber.

General installation

Thermostatic Valves

These fittings are mixing devices and therefore water supplies must be reasonably balanced.

Where connections are made to the mains cold water supply, WRC approved single check valves must be fitted to both hot and cold inlets. This is a stated requirement of Water Supply (Water Fittings) Regulations 1999 Schedule 2, Section 6

Before making any inlet pipe connections, all supply pipes MUST be thoroughly flushed to remove debris. Failure to do so could result in damage or low flow from the mixer unit. Water Supply (Water Fittings) Regulations 1999 Schedule 2 Section 4 G13.1

The fitting of isolating valves to the inlet feeds is advised for ease of maintenance. Please take great care when installing this mixer not to damage its surface.

Operating pressures (on hot and cold line) should be kept as balanced as possible in order to assure optimum efficiency.

Note: When pressure is higher than 5 bar a pressure reducer is required to be fitted before the valve.

Please note if installing in an enclosed environment, access should be left for servicing and maintenance. No costs relating to inadequate access can be accepted.

Operating Specifications

Hot Water Supply Temperature:

Maximum: 70° C Minimum: 10° C

Operating Pressure

Maximum: 5 bar Minimum: 0.5 bar

Flow rate

38°MIX (L/MIN)	0.2BAR	0.5BAR	1BAR	2BAR	3BAR
TWO-OUTLET	12	17	21	29	36
THREE-OUTLET	9	12	16	23	29

Operation:two-outlet

Operation:three-outlet

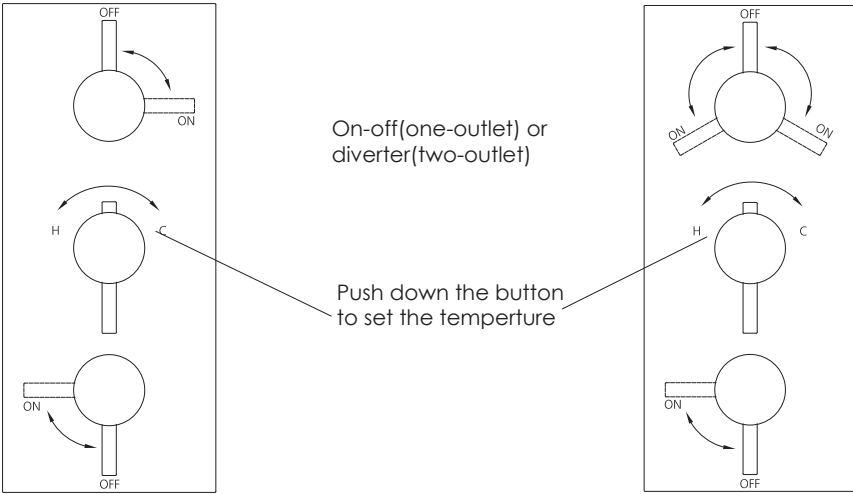

Dimensions - square and round corner backplate

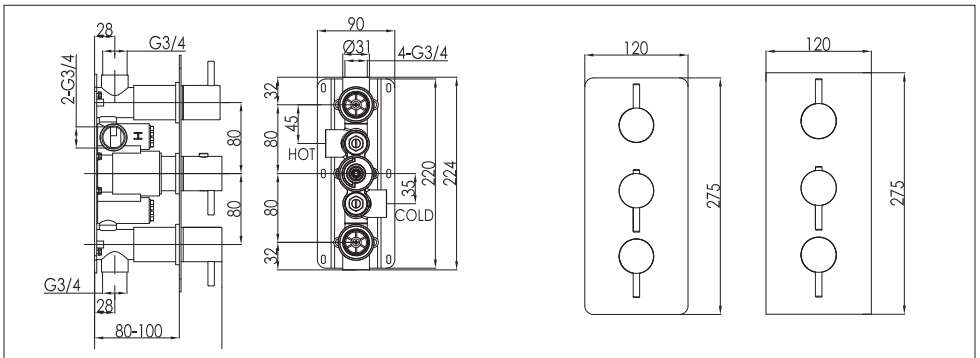

Service parts list

Two-outlet

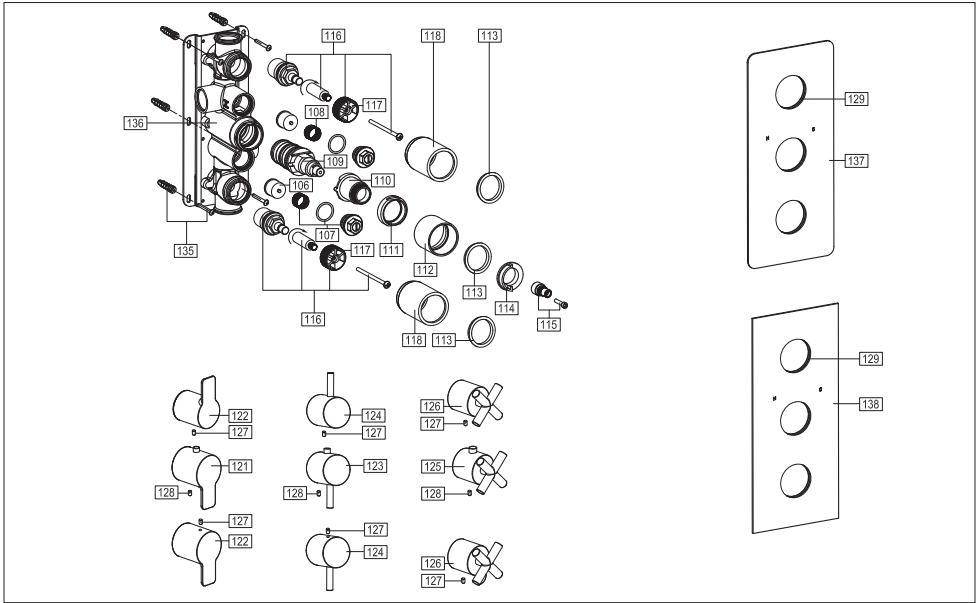

Three-outlet

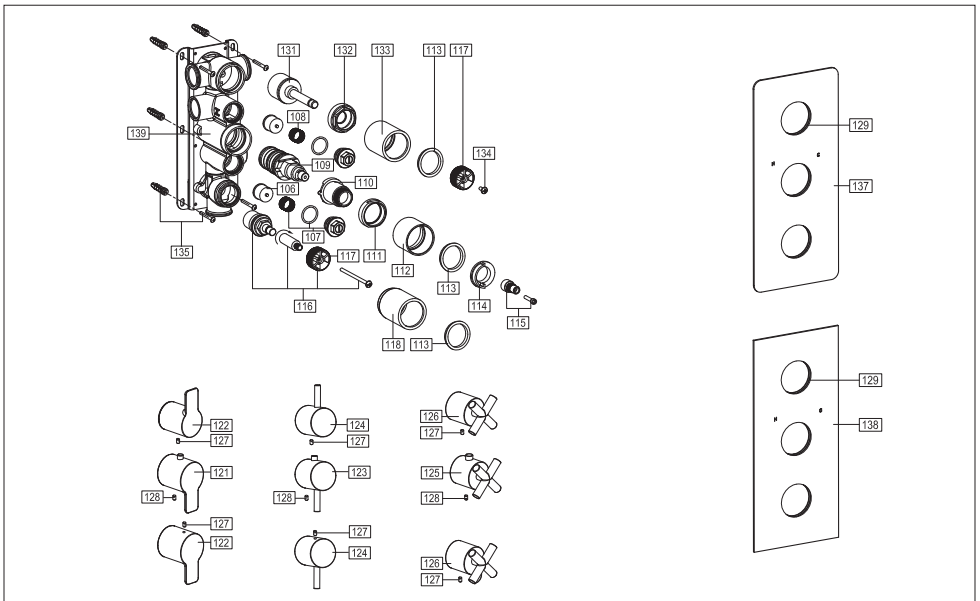

Installation - standard fixing

Rinse pipework thoroughly before fitting the valve: do not allow dirt, metal particles or shavings to block the filters fitted on inlets.

 **Warning!** Please check for any hidden cables and pipes before drilling holes in the wall.

Please ensure that sufficient access is left between the tile cut out to the non return valve housing and isolation point, in order to carry out maintenance when necessary.

The valve must be set into the wall between (80mm minimum – 100mm maximum).

If you are fitting the valve to a partition wall or a wall of particularly soft substrate you will need specialist fixings. Select the position for the shower valve and offer the shower valve to the wall, mark the 4 fixing points with a suitable pencil. Remove the shower valve from the wall, drill the holes to a suitable depth for the wall plugs and secure with suitable screws.

During and after installation protect the outer parts by leaving the clear plastic protective carton on the valve to avoid damage to plated surfaces.

Connect hot supply to left inlet of the valve and cold supply to right inlet.

Make all outlet connections to the valve.

If blanking plug at base of valve is removed for additional outlets, please ensure a separate volume control is installed i.e. stop valve, between valve and delivery point.

Apply a thin bead of silicone around the outside to seal against the tiled surface.

Installation - standard fixing

Please Note: For illustrative purposes only the square backplate installation is shown.

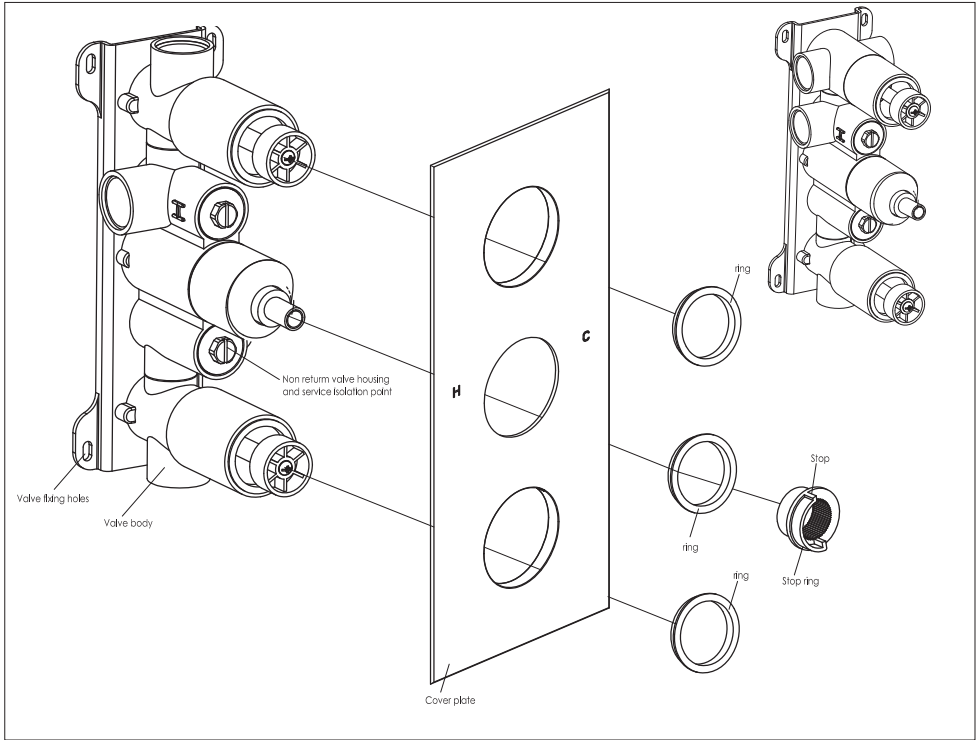

Installation - handles

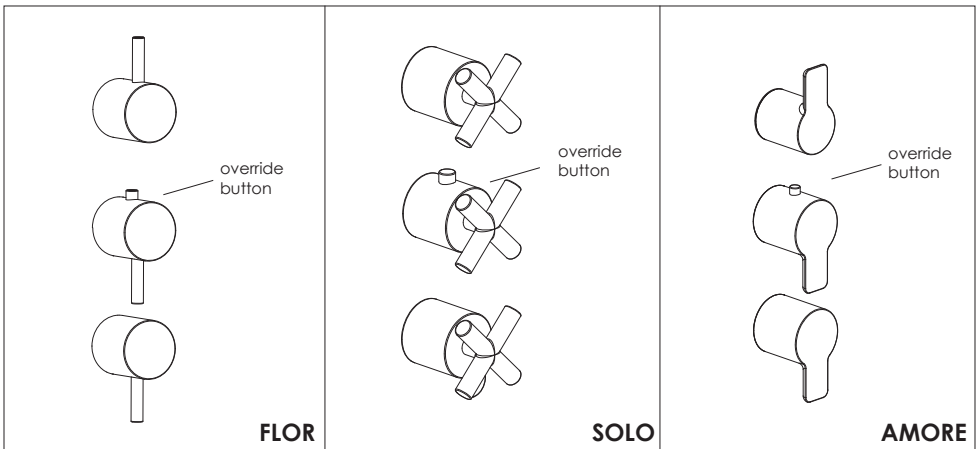

Flow control handle (top).

Carefully slide the flow control handle onto the splines of the top valve and secure in position with the grub screw on the underside.

Temperature control handle (bottom).

With the temperature override button pointing at 12 o'clock, press down on the button and push the handle onto the splines, being careful not to turn the spline of the valve, secure in position with the grub screw on the underside. Ensure the plastic spacer ring is firmly positioned inside the handle before installation.

Care of the mixer

Our products are finished to the highest standard and due care needs to be taken to ensure their looks are retained.

We recommend cleaning all products with a soft damp cloth ONLY and advise strongly against the use of ALL cleaning products i.e. powders and liquids.

If the above instructions are not followed this will invalidate your guarantee in the event of a problem occurring.

Temperature resetting

The valve has been factory set under balance pressures and hot water supply at 65° C. When your specific operating conditions are significantly different from the above, the temperature of the water may vary from the setting.

When the difference is too great, you can adjust the calibration of the valve to suit individual requirements of the installation:

1. Select 38° C or the arrow on the handle and check the temperature of the water being delivered to the outlet with a thermometer.
2. If the temperature is unacceptable proceed to reset the calibration as follows: Remove the handle. Do not remove the plastic stop ring. Turn the spline of the valve clockwise to decrease the temperature and anti-clockwise to increase the temperature until 38° is achieved at outlet.
3. Ensure that the stop on the stop ring is at 12 o'clock and replace the handle with the temperature override button also pointing at 12 o'clock being careful not to turn the spline of the valve, replace the handle.

Our valve setting is now calibrated.

Non return valves.

Undo both hex nuts each side of the cartridge using a suitable spanner. Pull out the non return valve, rinse in water to remove the dirt, and then soak them in vinegar or descaling agent. Grease the 'O' rings using a suitable silicone lubricant and replace.

Cartridge Filters

To clean the filters, you must first remove the cartridge from the housing.

Removing the Cartridge

1. Shut off the water supply to both inlets at the isolating valves.
2. Remove the handle, cover plate ring, cover plate to gain access to back of valve.
3. Remove the thermostatic cartridge by unscrewing with a spanner.
4. Clean the filters by rinsing them in water to remove the dirt and soaking them in vinegar or descaling agent.
5. Before reassembling the cartridge, clean its housing with a wet cloth and grease the 'O' rings using a suitable silicone lubricant. Reassemble the cartridge.
6. Place cartridge back into valve and tighten the nut with a spanner.
7. Place the black plastic stop ring so that the stop is at the 12 o'clock position.
8. Make sure everything is tight and secure, turn on the water supply at the isolating valves.
9. Now check the water temperature to ensure correct calibration (see page 6 for temperature resetting).
10. Replace the handles and cover plate.